

YAMAHA CDV-1700



Natural Sound CD CDV LD Player

Horizontal Resolution of 440 Lines: Video Signal-to-Noise Ratio of 48 dB

High Jitter Suppression Circuit Eliminates Screen Drift and Color Irregularities for All Disc Sizes

8 fs Oversampling, 18-bit Twin Digital/Analog Converter

Built-in A/D Converter Provides Rich Sound from Both Analog and Digital Sources

Complete Disc Compatibility — All Six CD, CDV, and LD Formats

S Video Output Terminal for Much Clearer Reproduction

Full Remote Control Operation

Thank you for purchasing the YAMAHA CD CDV LD Player CDV-1700.

NTSC



OWNER'S MANUAL



TABLE OF CONTENTS

Safety Instructions	1	Disc Play (CD, CDV, LD)	22
Caution	3	Search Operation (CD, CDV, LD)	25
The Type of Discs which can be played on this unit	4	Program Play (CD, CDV, LD)	27
Accessories	6	Still / Step Play (CAV)	28
Connections	7	Repeat Play (CD, CDV, LD)	29
Location and Function of Parts and Controls	12	Multiple Speed Play (CAV)	30
Notes on the Remote Control Transmitter	19	Troubleshooting	31
Disc Handling Precautions	20	Specifications	33

IMPORTANT

Please record the serial number of your unit in the space below.

Model: **CDV-1700**

Serial No:

The serial number is located on the rear of the unit. Retain this Owner's Manual in a safe place for future reference.

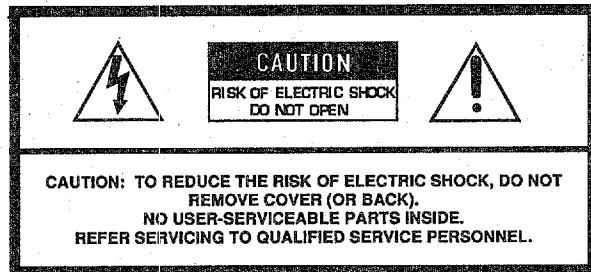

• Explanation of Graphical Symbols



The lightning flash with arrowhead symbol, within an equilateral triangle, is intended to alert you to the presence of uninsulated "dangerous voltage" within the product's enclosure that may be of sufficient magnitude to constitute a risk of electric shock to persons.



The exclamation point within an equilateral triangle is intended to alert you to the presence of important operating and maintenance (servicing) instructions in the literature accompanying the appliance.

WARNING

To reduce the risk of fire or electric shock, do not expose this appliance to rain or moisture.

SAFETY INSTRUCTIONS

- 1** Read Instructions – All the safety and operating instructions should be read before the appliance is operated.
 - 2** Retain Instructions – The safety and operating instructions should be retained for future reference.
 - 3** Heed Warnings – All warnings on the appliance and in the operating instructions should be adhered to.
 - 4** Follow Instructions – All operating and other instructions should be followed.
 - 5** Water and Moisture – The appliance should not be used near water – for example, near a bathtub, washbowl, kitchen sink, laundry tub, in a wet basement, or near swimming pool, etc.
 - 6** Carts and Stands – The appliance should be used only with a cart or stand that is recommended by the manufacturer.
- 6A** An appliance and cart combination should be moved with care. Quick stops, excessive force, and uneven surfaces may cause the appliance and cart combination to overturn.
- 
- 7** Wall or Ceiling Mounting – The appliance should be mounted to a wall or ceiling only as recommended by the manufacturer.
 - 8** Ventilation – The appliance should be situated so that its location or position does not interfere with its proper ventilation. For example, the appliance should not be situated on a bed, sofa, rug or similar surfaced that may block the ventilation openings; or placed in a built-in installation, such as a bookcase or cabinet that may impede the flow of air through the ventilation openings.
 - 9** Heat – The appliance should be situated away from heat sources such as radiators, stoves, or other appliances that produce heat.

- 10** Power Sources – The appliance should be connected to a power supply only of the type described in the operating instructions or as marked on the appliance.
- 11** Power-Cord Protection – Power-supply cords should be routed so that they are not likely to be walked on or pinched by items placed upon or against them, paying receptacles, and the point where they exit from the appliance.
- 12** Cleaning – The appliance should be cleaned only as recommended by the manufacturer.
- 13** Non use Periods – The power cord of the appliance should be unplugged from the outlet when left unused for a long period of time.
- 14** Object and Liquid Entry – Care should be taken so that objects do not fall into and liquids not spilled into the inside of the appliance.
- 15** Damage Requiring Service – The appliance should be serviced by qualified service personnel when:
 - A.** The power-supply cord or the plug has been damaged or
 - B.** Objects have fallen, or liquid has been spilled into the appliance; or
 - C.** The appliance has been exposed to rain; or
 - D.** The appliance does not appear to operate normally or exhibits a marked change in performance; or
 - E.** The appliance has been dropped, or the cabinet damaged.
- 16** Servicing – The user should not attempt to service the appliance beyond those means described in the operating instructions. All other servicing should be referred to qualified service personnel.
- 17** Power Lines – An outdoor antenna should be located away from power lines.

18 Outdoor Antenna Grounding — If an outside antenna or cables system is connected to the unit, by sure the antenna or cable system is grounded so as to provide some protection against voltage surges and built-in static charges. Section 810 of the National Electrical Code, ANSI/NFPA No. 70-1984, provides information with respect

to proper grounding of the mast and supporting structure, grounding of the lead-in wire to an antenna discharge unit, size of grounding conductors, location of antenna-discharge unit, connection to grounding electrodes, and requirements for the grounding electrode.

19 Polarization — This unit is equipped with a polarized alternating-current line plug (a plug having one blade wider than the other). This plug will fit into the power outlet only one way. This is a safety feature. If you are unable to insert the plug fully into the outlet, contact your electrician to replace your obsolete outlet. Do not defeat the safety purpose of the polarized plug.

20 Replacement Parts — When replacement parts are required, be sure the service technician has used replacement parts specified by the manufacturer or have the same characteristics as the original part. Unauthorized substitutions may result in fire, electric shock or other hazards.

21 Safety Check — Upon completion of any service or repairs to this video product, ask the service technician to perform safety checks to determine that the video product is in proper operating condition.

EXAMPLE OF ANTENNA GROUNDING ACCORDING TO NATIONAL ELECTRICAL CODE INSTRUCTIONS (CONTAINED IN ARTICLE 810 — "RADIO AND TELEVISION EQUIPMENT")

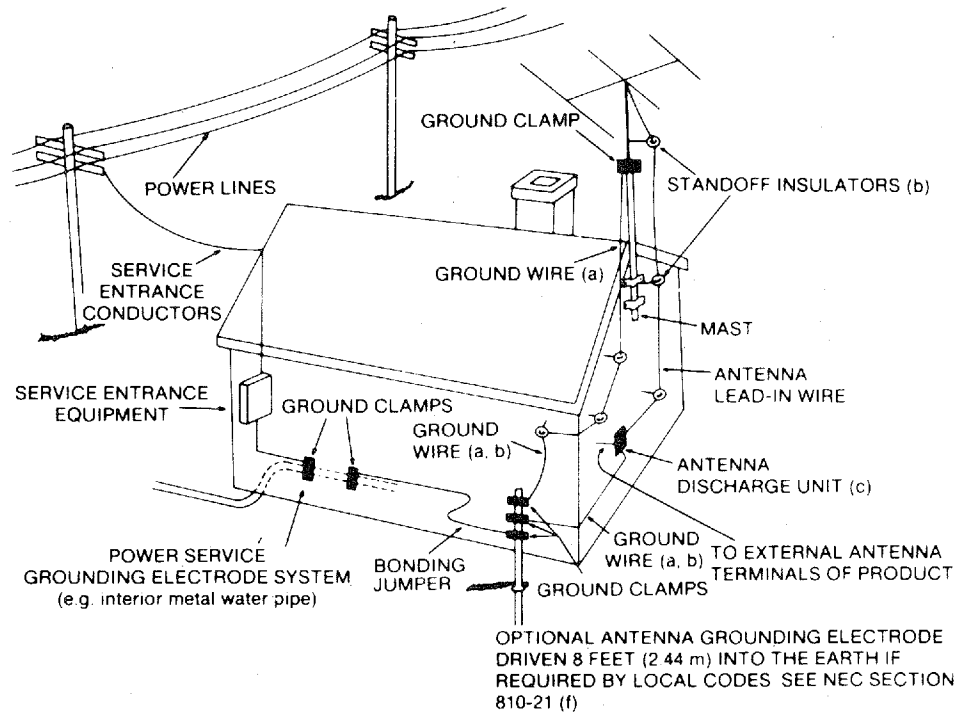

(a) Use No. 10 AWG (5.3 mm²) copper, No. 8 AWG (8.4 mm²) aluminum, No. 17 AWG (1.0 mm²) copper-clad steel or bronze wire, or larger, as a ground wire

(b) Secure antenna lead-in and ground wires to house with stand-off insulators spaced from 4 — 6 feet (1.22 — 1.83 m) apart

(d) Use jumper wire not smaller than No. 6 AWG (13.3 mm²) copper, or the equivalent when a separate antenna-grounding electrode is used. See NEC Section 810-21 (j)

(c) Mount antenna discharge unit as close as possible to where lead-in enters house

CAUTION: READ THIS BEFORE OPERATING YOUR UNIT.

- 1 To ensure the finest performance, please read this manual carefully. Keep it in a safe place for future reference.
- 2 Install your unit in a cool, dry, clean place – away from windows, heat sources, and too much vibration, dust, moisture or cold. Avoid sources of hum (transformers, motors). To prevent fire or electrical shock, do not expose to rain and water.
- 3 Do not operate the unit upside-down. It may overheat, possibly causing damage.
- 4 Never open the cabinet. If a foreign object drops into the set, contact your dealer.
- 5 Do not place records or other objects on top of the unit; this will block the ventilation holes, cause the internal temperature to rise and may result in a failure.
- 6 Do not use force on switches, knobs or cords. When moving the set, first turn the unit off. Then gently disconnect the power plug and the cords connecting to other equipment. Never pull the cord itself.
- 7 Do not attempt to clean the unit with chemical solvents: this might damage the finish. Use a clean, dry cloth.
- 8 Be sure to read the "Troubleshooting" section on common operating errors before concluding that your unit is faulty.
- 9 To prevent lightning damage, pull out the power cord and remove the antenna cable during an electrical storm.

This unit can only be used for NTSC system. For PAL and SECAM system, this unit cannot be used.

Information about FCC Rules

This equipment generates and uses radio frequency energy and if not installed and used properly, that is, in strict accordance with the manufacturer's instructions, may cause interference to radio and television reception. It has been type tested and found to comply with the limits for a Class B computing device in accordance with the specifications in Subpart J of Part 15 of FCC Rules, which are designed to provide reasonable protection against such interference in a residential installation.

However, there is no guarantee that interference will not occur in a particular installation. If this equipment does cause interference to radio or television reception, which can be determined by turning the equipment off and on, the user is encouraged to try to correct the interference by one or more of the following measures:

Reorient the receiving antenna.

Relocate this unit with respect to the radio or TV receiver.

Move this unit away from the radio or TV receiver. connect this unit to a different AC outlet so that this unit and the radio or TV receiver are on different electrical circuits.

If necessary, the user, should consult the dealer or an experienced radio/television technician for additional suggestions. The user may find the following booklet prepared by the Federal Communications Commission helpful: "How to Identify and Resolve Radio-TV Interference Problems".

This booklet is available from the U.S. Government Printing Office, Washington, DC 20402, Stock No. 004-000-00345-4.

Note to CATV system installer:

This reminder is provided to call the CATV system installer's attention to Article 820-22 of the NEC in USA (and to the Canadian Electrical Code in Canada) that provides guidelines for proper grounding and, in particular, specifies that the cable ground shall be connected to the grounding system of the building, as close to the point of cable entry as practical.

WARNING

DANGER

Invisible laser radiation when open and interlock failed or defeated.
Avoid direct exposure to beam.





CAUTION

Use of controls or adjustments or performance of procedures other than those specified herein may result in hazardous radiation exposure.

- * As the laser beam used in this compact disc player is harmful to the eyes, do not attempt to disassemble the cabinet. Refer servicing to qualified personnel only.
- * To avoid electrical shock, do not open the unit. Refer servicing to qualified personnel only.

THE TYPE OF DISCS WHICH CAN BE PLAYED ON THIS UNIT

● The disc marks are found on the disc labels or jackets.

Mark	Disc	Size	Marked sides	Audio Recording Format	Video Recording Format	Possible Searches	Remarks
	 CD Single	8cm (3")	1 side	Digital (max. 20 min.)		Track search Index search	TOC (*1)
	CD (Compact Disc)	12cm (5")	1 side	Digital (max. 70 min.)		Track search Index search	TOC INDEX (*2)
	CDV (Compact Disc Video)	12cm (5")	1 side	Digital (max. 20 min.)	CLV (*3) (max. 5 min.)	Track search Index search	TOC INDEX
	CDV-LD (CDV format Laser Disc)	20cm (8") or 30cm (12")	2 sides or 1 side	Digital and Analog	CAV (*4) or CLV	Chapter/Track search Quick index search (CLV) Index search Frame No. search (CAV) Time No. search (CLV)	TOC INDEX
	LD (Laser Disc)	20cm (8") or 30cm (12")	2 sides or 1 side	Digital and analog (*5) or Analog only	CAV or CLV	Chapter search Quick index search (CLV) Frame No. search (CAV) Time No. search (CLV)	



This unit can play LDs (Laser Discs) carrying this mark, which is an international unified mark for videodiscs. Do not attempt to play other types of videodiscs, such as CED and VHD videodiscs.

This unit has been designed for use with the NTSC format, which is the color television format used in North America and other areas. Do not use discs or a TV made for other television formats (PAL, SECAM) with this unit.

TOC (*1)

Every CD and CDV type disc is provided with a section called TOC (Table Of Contents) at the beginning of the disc. The TOC is just like the table of contents of a book, and contains information on the contents (number of tracks, playing time, etc.) of the disc.

INDEX (*2)

When a CD or CDV disc contains a musical work composed of several movements, each of the movements is sometimes given a number called an "index". When playing such a disc, it can be played starting from one of the indexed positions. For details, please read the explanation on the disc before playing it.

- Discs containing a record of index numbers usually carry  mark on the instruction booklet.

Notes on video recording formats (*3, *4)

● Standard disc/CAV disc

A CAV (Constant Angular Velocity) disc contains a video signal recorded at a constant interval from the center to the edge of the disc. With a standard disc, 54,000 video signal frames can be recorded on one side, which corresponds to 30 minutes of playback.

All frames on a standard disc are assigned a frame number, which makes it possible to perform trick plays (still / frame advance, variable-speed playback) and auto picture stop, as well as chapter search, frame search and various repeat playback functions.

● Long-play disc/CLV

A CLV (Constant Linear Velocity) disc rotates at variable speeds, so that the recording speed is constant at the inner and outer parts of the disc (Inner part: 1800 rpm to Outer part: 600 rpm). The maximum video signal recording length is 60 minutes per side. Trick plays (still / frame advance, variable-speed playback, auto picture stop) are not possible with a CLV disc, but Chapter search, time search and repeat playback are possible.

Notes on audio signals (*5)

Some LD discs contain both digital and analog audio signals, so that either of them can be selected during playback. (Discs containing digitally-recorded audio carry the  mark on their jackets.)

This unit is equipped with an audio switch key that allows you to select the digital or analog audio signal from such discs.

Laser multi-audio discs with digital audio

Discs carrying the  mark on their jackets or labels contain the digital and analog audio signals, so that the desired contents can be selected during playback. For details, please refer to the "SELECTING THE ANALOG/DIGITAL AUDIO SIGNAL" section.

ACCESSORIES

After unpacking, check that the following accessories are contained.

- Remote control transmitter

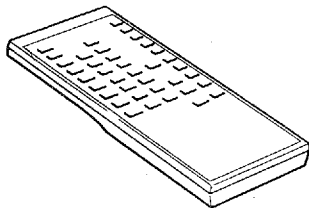

- Batteries

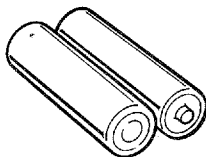

- 75-ohm/300-ohm antenna adapter

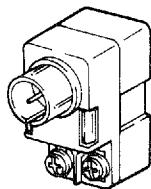

- Coaxial cable with F-type connector

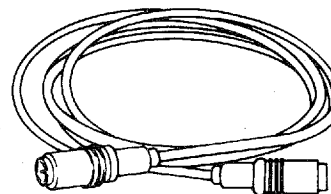

- Audio cord

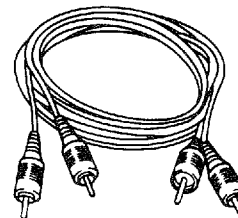

- Video cord

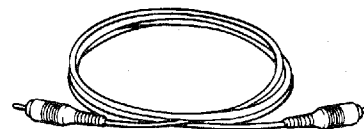

CONNECTIONS

During connection, be sure to disconnect the power cords of this unit and television set from the AC outlet. Do not turn the power on until all connections are completed.

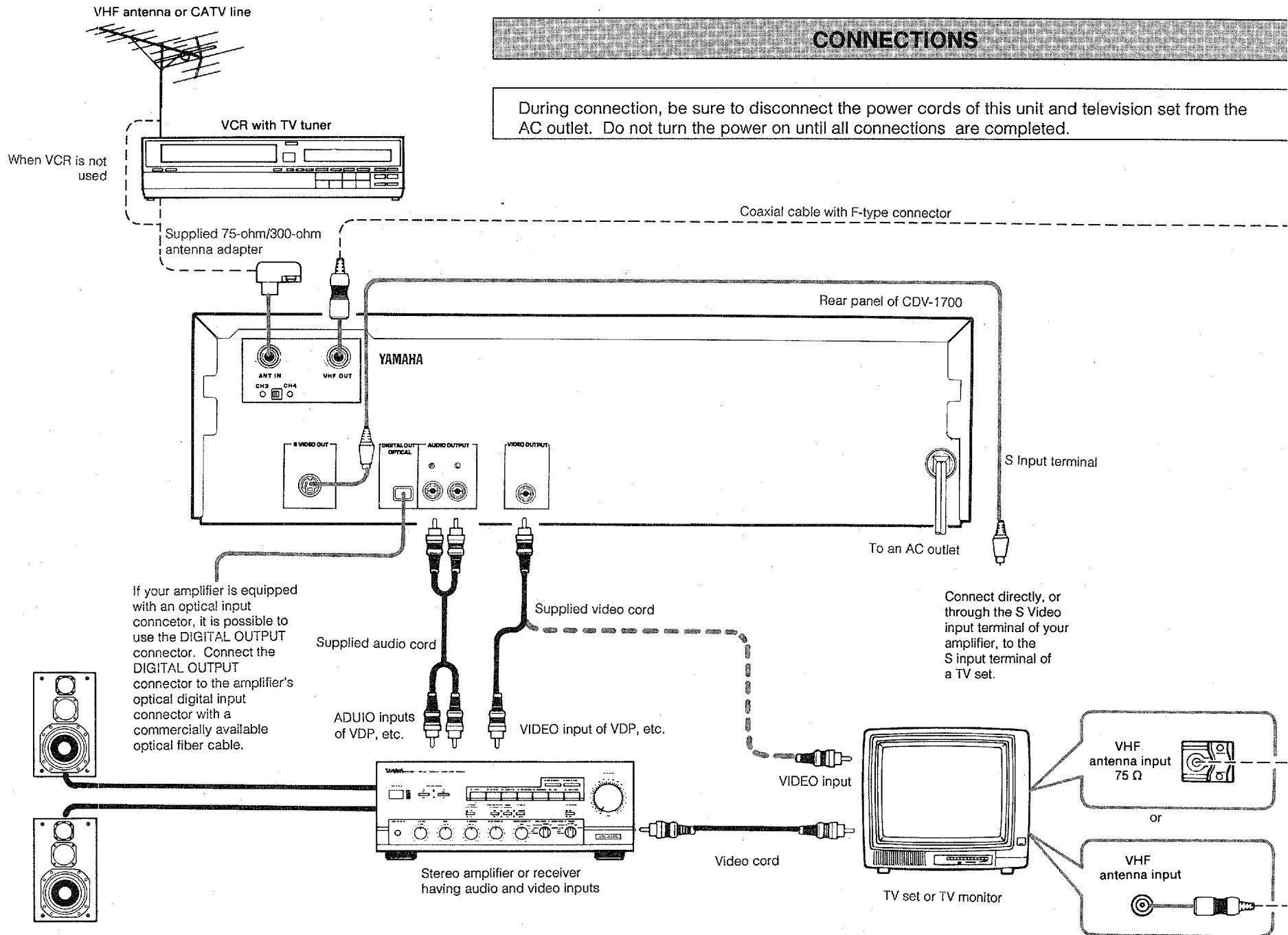

■ CONNECTION EXAMPLES

A. With a stereo amplifier or receiver having audio and video inputs and a television set having video input

Connect as shown by a thick solid line (——).

* The connection shown by a thin solid line is an alternative.

B. With a television set having video input and a stereo amplifier or receiver having audio input only

Connect as shown by a thick dashed line (==) for video signal, with the connection shown by a thick solid line for audio signal as it is.

C. With a television set having no video input and a stereo amplifier or receiver

Connect as shown by a thin dashed line (----) for video signal, with the connection shown by a thick solid line for audio signal as it is.

- VCR can be used, connecting as shown by a thin dashed line (----), in combination with any one of the above connection examples A, B, and C.

■ How to connect the supplied coaxial cable with F-type connector to the television set having no F-type antenna Terminal

1. Cut off one of the supplied coaxial cable with F-type connector.
2. Process the cut end and connect it to the antenna terminal of the television set as shown below.

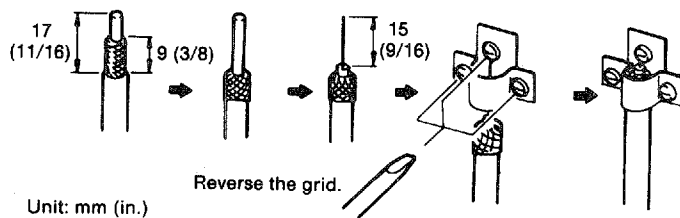

■ How to use the supplied 75-ohm/300 ohm antenna adapter

● When using a 300-ohm feeder

1. Connect the feeder cable to the terminals of the supplied 75-ohm/300-ohm antenna adapter.

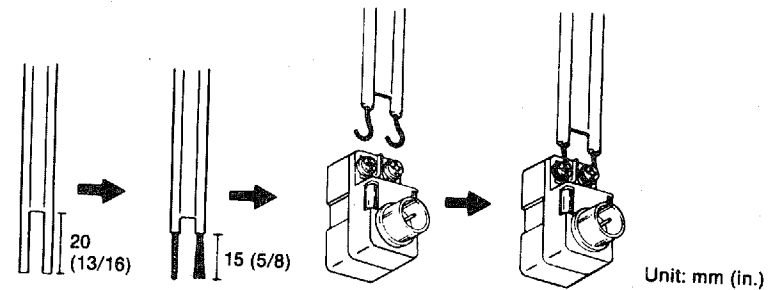

2. Plug the antenna adapter into the ANT IN terminal of this unit firmly.

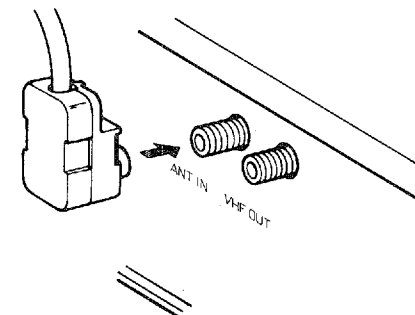

● **When using a 75-ohm coaxial cable**

1. Remove the cover of the supplied 75-ohm / 300-ohm antenna adapter by pressing the locking lugs inward.

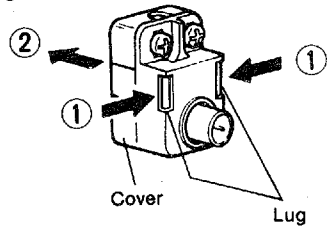

2. Cut the end of the 75-ohm coaxial cable and process it as shown below.

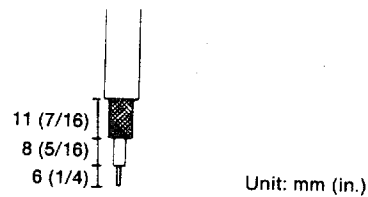

3. Cut off the red lead and remove it.

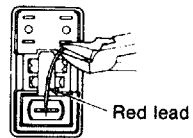

4. Insert the cable wire through the hole as shown below and clamp it with pliers.

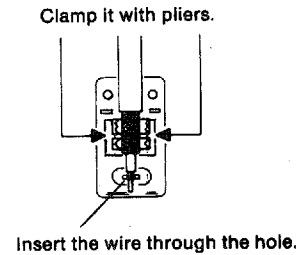

5. Replace the cable end of the cover and snap into place by pressing the adapter together.

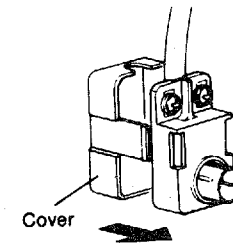

6. Plug the 75-ohm/300-ohm antenna adapter into the ANT IN terminal of this unit.

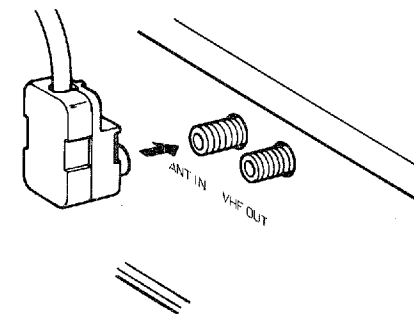

■ VHF and UHF signals transmission

When both VHF and UHF signals are transmitted with one cable using a UHF/VHF mixer, a signal splitter is used to separate the signals. In this case, connect the VHF output from the splitter to the ANT IN terminal of this unit and connect the UHF output to the UHF input of the television set. The VHF television broadcasting can be seen by switching the VHF select key of the remote control transmitter.

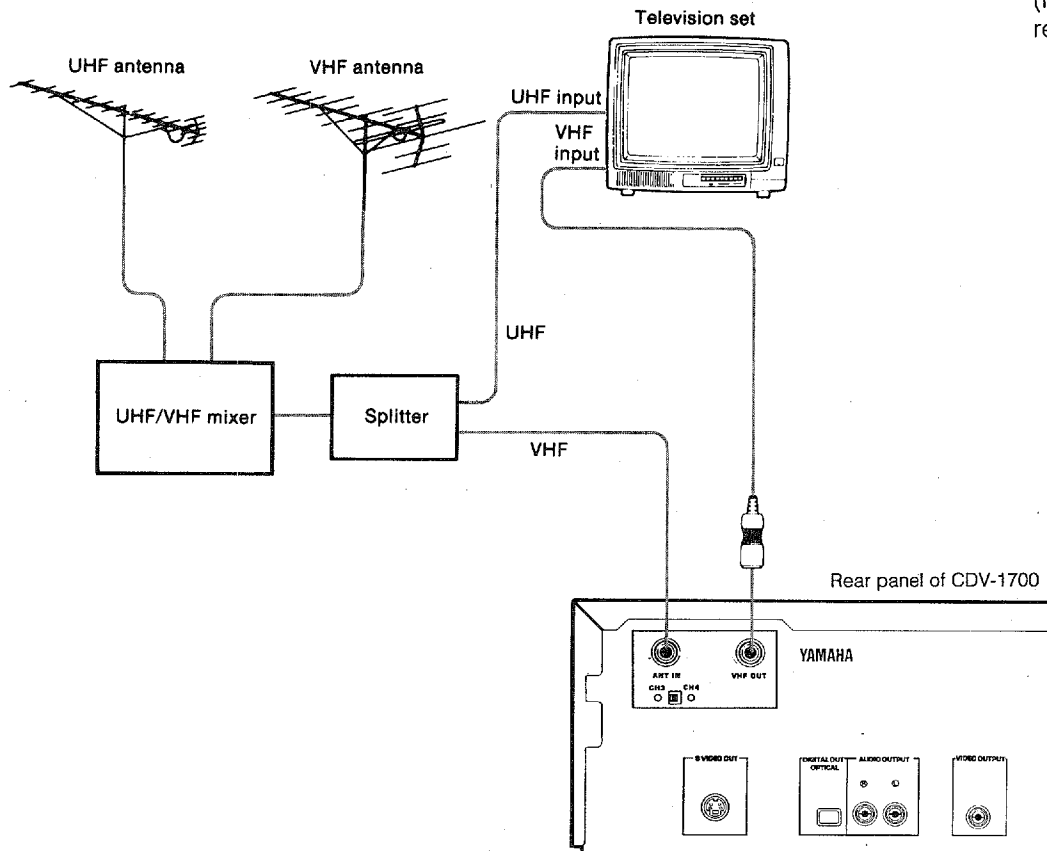

- **Set the VHF CHANNEL select switch to either channel 3 or 4, whichever is a vacant channel (When used with televisions having no video/audio input terminals)**

In the unit, the video and audio signals are converted to a VHF signal which is the same as the television broadcast signal and output to a vacant channel of your television (channel 3 or 4).

When the channel 3 has no broadcast station in your area, set the VHF CHANNEL select switch to 3 (right side) position, when channel 4 has no broadcast station in your area, set it to 4 (left side) position.

(For a General model, LOW and HIGH are indicated instead of CH3 or CH4 respectively.)

■ **Set the television reception channel to 3 or 4**
(When using television having no video/ audio input terminals)

All video signals are converted into VHF channel 3 or 4 signals so that the picture from the disc can be seen on the television screen.
If the picture is not seen clearly, tune to the channel exactly, referring to the instruction manual of television.

- * When using with monitors or stereo systems, turn on the units for this adjustment.
- * When using television having audio inputs, set the external input selector of television set to "video".

■ **TO WATCH A TELEVISION BROADCAST**

- **When Using a Television Having No Video / Audio Input Terminals**
Press the VHF select key so that the ANT indicator lights or turn off the player's power.

VHF antenna input signal is connected to the television through this unit.

- * When the ANT indicator is lit as above, the disc rotates in the player while the television broadcast is seen on the screen. When watching the television broadcast for long periods, be sure to turn off the player's power.

- **When Using a Television Having Video / Audio Input Terminals**

1. Take out the disc and turn the player's power off.
2. Set the television to the TV broadcast receiving mode by selecting the desired channel or external input selector.

(For details, refer to the instruction manual of the television being used.)

LOCATION AND FUNCTION OF PARTS AND CONTROLS

FRONT PANEL

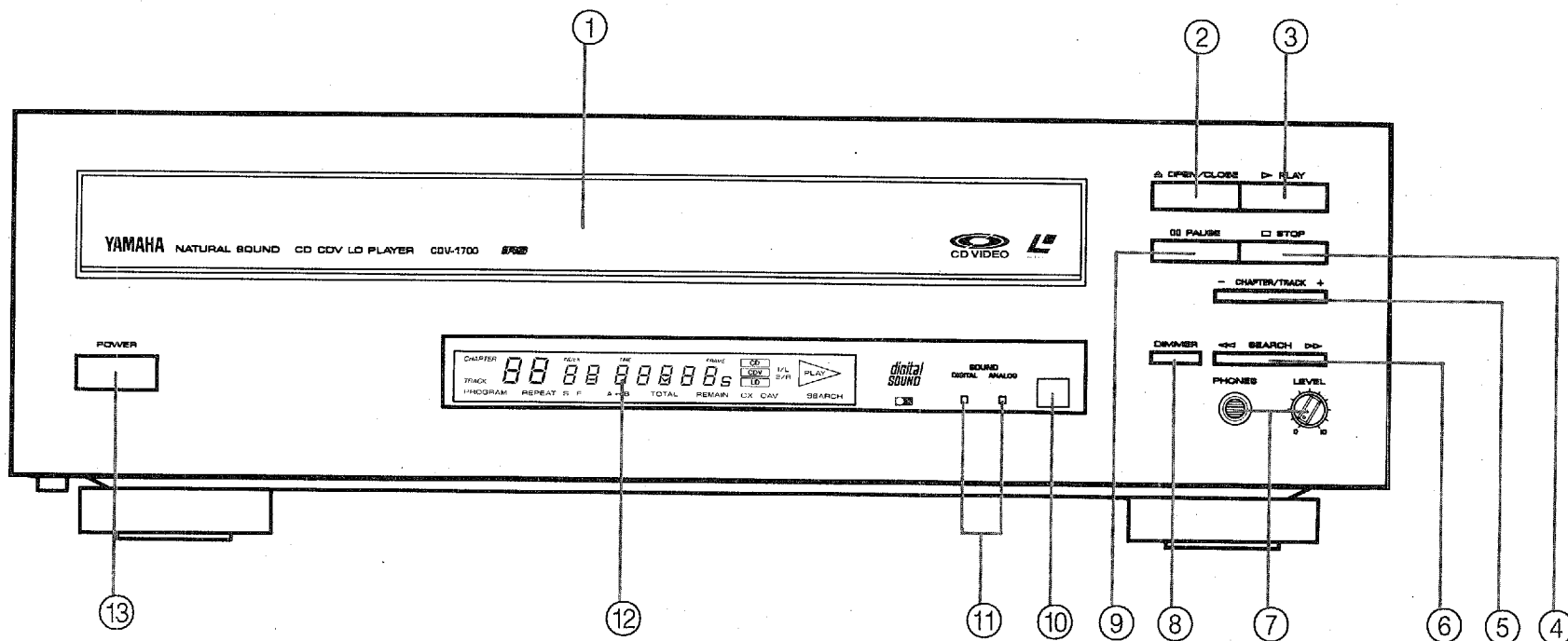

① Disc tray

Load a disc onto this tray.

The tray is opened by pressing the OPEN / CLOSE key of the player or by pressing the OPEN / CLOSE-FULL AUTO PLAY key on the remote control transmitter.

② OPEN/CLOSE key

Press this key to open or close the disc tray.

Pressing this key during play stops the play and opens the disc tray.

The CD / CDV / LD indicators flash during opening/closing.

Pressing this key when the disc tray is open and a disc is placed in the tray, closes the tray and starts play.

The PLAY indicator lights while a disc is playing.

③ PLAY key

Press this key to start play. When this key is pressed while the disc tray is opened, the disc tray closes and the unit enters play mode. When this key is pressed during other modes (pause, still, etc.), its mode is released and normal play is resumed.

④ STOP key

Press this key to stop play.

When this key is pressed while the disc tray is opened, the disc tray closes, and the unit enters stop mode.

⑤ CHAPTER/TRACK key

+: When + side of this key is pressed during play, the beginning of the next chapter or track is detected. When it is kept pressed, the chapter or track number is advanced continuously.

-: When - side of this key is pressed during play, the beginning of the current chapter or track is detected. If it is kept pressed, the chapter or track number is reversed continuously. These keys are also used for re-programming or to skip between programs during program play.

⑥ SEARCH key

▶▶: When ▶▶ side of this key is pressed during play, play is advanced at high speed.
◀◀: When ◀◀ side of this key is pressed during play, play is reversed at high speed.

In the search mode, during the first 3 seconds, play is advanced at lower speed (about 15 times faster than normal play speed), after this time play is advanced at higher speed (about 60 times faster).

* In this mode, sound from the LD, CDV-LD, or the video section of a CDV is not produced.

⑦ Head PHONES jack and PHONES LEVEL control

Insert a headphone plug into the PHONES jack for private listening. To increase the output level from the headphones jack, turn the PHONES LEVEL control clockwise. To decrease the output level from the headphones jack, turn it counterclockwise.

⑧ DIMMER key

Press this key once to dimly light the display, and press this key again to distinguish all indications on the display window.

⑨ PAUSE key

Press this key to temporarily stop the disc play. To resume play from the pause point, press the PLAY key. When this key is pressed while the disc tray is opened, the disc tray closes, and the unit enters pause mode.

⑩ REMOTE SENSOR

This receives the infrared signal from the remote control transmitter.

⑪ SOUND indicators

DIGITAL lights when the disc being played has a digital sound signal, and ANALOG lights when the disc being played has an analog sound signal.

⑫ Display window

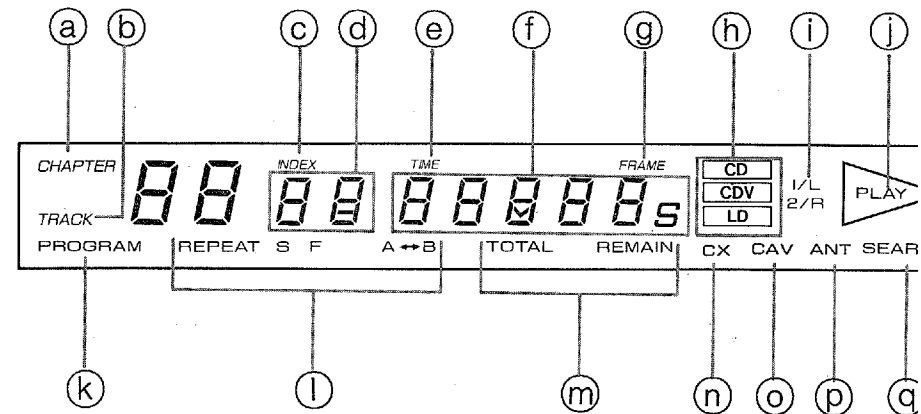

① CHAPTER indicator

Indicates the chapter No. of a CDV-LD or LD disc.

② TRACK indicator

Indicates the track No. of a CD, CDV, or CDV-LD disc.

Ⓒ INDEX Indicator

Indicates the index No. of the CD, CDV or CDV-LD.

Ⓓ Index/Program No. display

Ⓔ TIME display

Displays the total play time of the LD disc, or total play time of the CD or CDV selection being played.

Ⓕ Time display / Frame No. display

Ⓖ FRAME Indicator

Indicates the frame No. of a CAV disc.

Ⓗ LD / CDV / CD indicators

Indicates the kind of disc that was loaded and flashes while the disc tray is opening or closing.

Ⓘ Sound track indicator

Indicates the sound track mode.

⓫ PLAY Indicator

Lights during play.
In pause mode, this indicator flashes.

Ⓚ PROGRAM Indicator

Lights when programming the selection or during program play.

Ⓛ REPEAT S / F / A-B indicators

REPEAT S (Single) indicator:

Lights when the REPEAT key on the remote control transmitter is pressed. The S indicator flashes when the SINGLE PLAY key on the remote control transmitter is pressed and the unit is set to single play mode.

REPEAT F (Full) indicator:

Lights when the REPEAT key on the remote control transmitter is pressed and the unit is set to full repeat mode.

REPEAT A-B indicator:

Lights when the A-B key on the remote control transmitter is pressed twice and the unit is set to A-B repeat mode.

Ⓜ REMAIN TIME/TOTAL TIME display

REMAIN TIME:

Displays the remaining play time on a CD or CDV disc.

TOTAL TIME:

Displays the total time of a CD or CDV disc.

Ⓝ CX indicator

Lights when the disc recorded with the CX noise reduction system is played.

Ⓞ CAV indicator

Lights when a CAV disc is loaded.

Ⓟ ANT indicator

Lights when the VHF output mode is selected with the VHF key on the remote control transmitter.

Ⓠ SEARCH indicator

Lights when the search function is activated.

Ⓡ POWER switch

Press this switch to turn power on and off.

REAR PANEL

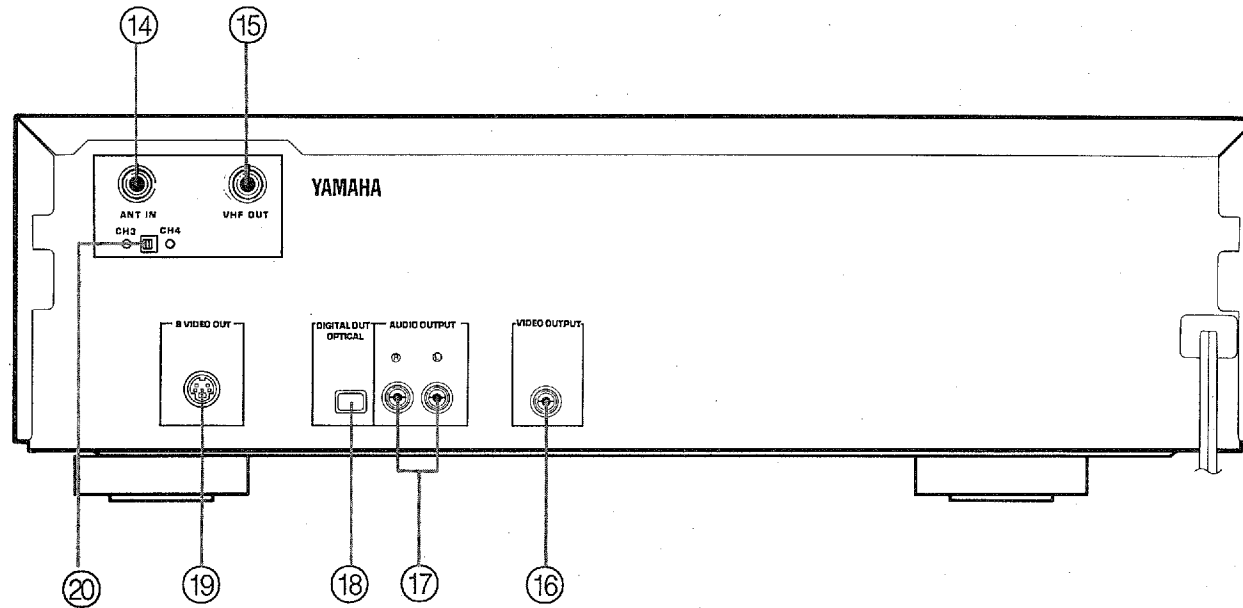

⑭ ANT IN terminal

The broadcast signal from the VHF TV antenna or the VHF signal from VCR is input to this terminal.
When this unit is used with a VCR, connect the VHF output terminal of the VCR to this terminal.

⑮ VHF OUT terminal

This terminal outputs the audio and video signals from the TV antenna or player which are converted to a VHF signal (channel 3 or 4) by the built-in RF converter.
At this terminal, the audio signal is output in monaural.

⑩ VIDEO OUTPUT jack

Outputs the video signal. Connect the video signal from this jack to the VIDEO IN jack of the TV monitor, etc.

⑪ AUDIO OUTPUT jacks

R/L output jacks:

Output the audio signal in stereo.

- When the television or VCR to be used has stereo input jacks, use these jacks.

The output audio signals are different according to the type of discs. See the table below.

Player Disc	L / R Jacks	DIGITAL OUTPUT Jack
CD, 12 cm CDV	Digital audio sound is output in stereo.	Digital audio signal is output in stereo.
20 cm / 30 cm CDV or LD with the <i>digital sound</i> mark	Digital or analog audio sound is output in stereo. * The digital and analog audio can be selected.	Digital audio signal is output as it is recorded, or analog audio signal is converted into digital signal before being output.
LD without the <i>digital sound</i> mark	Analog audio signal is output in stereo.	Analog audio signal is converted into a digital signal before being output.

⑫ OPTICAL DIGITAL OUTPUT connector

Outputs the digital audio signal. (The analog audio signal has been converted into a digital signal and is output as a digital audio signal.)

Connect this connector to the optical input connector of an amplifier with a commercially available optical fiber cable.

⑬ S VIDEO OUT connector

With the connection to a TV set having an S VIDEO input, a high resolution picture will be obtained, resulting in a much clearer reproduction.

- As the video signal is output simultaneously at the S VIDEO OUT connector and the VIDEO OUTPUT jack when both S VIDEO connection and VIDEO OUTPUT jack connection are made, select either with a TV control.

⑭ VHF CHANNEL select switch

This switch is for selecting either VHF OUT channel 3 or 4. Whichever is not used in your area: channel 3 (L) or channel 4 (H) so that the output signal from the VHF OUT terminal can be received on your television.

(For a General model, LOW and HIGH are indicated instead of CH3 and CH4 respectively.)

I/O PORT (For a General model only)

Do not connect any unit to the I/O PORT on the rear panel, which is for use of adjustment at the factory.

REMOTE CONTROL TRANSMITTER

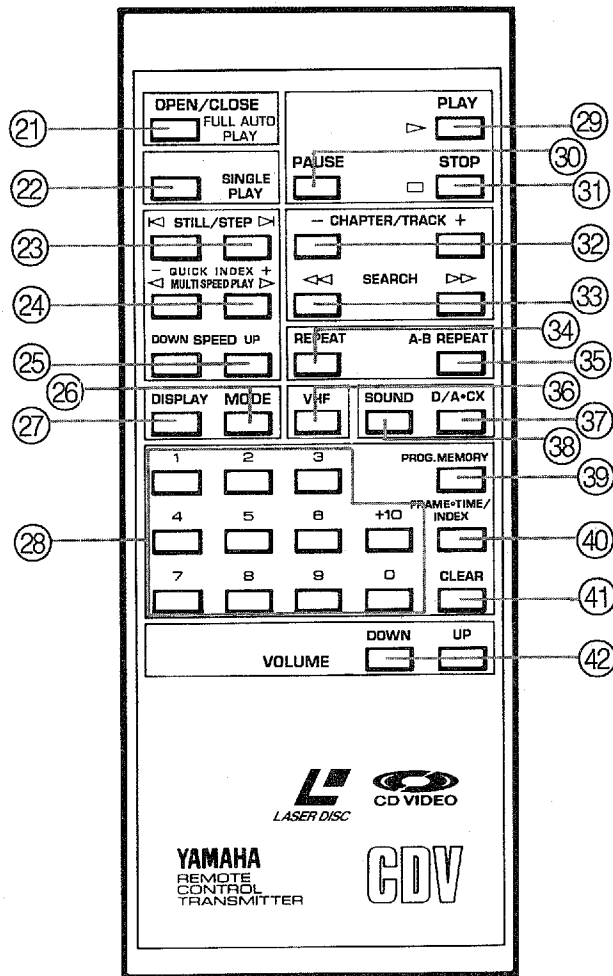

21 OPEN/CLOSE-FULL AUTO PLAY key

Press this key to open /close the disc tray. This key has entirely the same function as the OPEN / CLOSE key on the player.

22 SINGLE PLAY key

When this key is pressed, the player enters pause mode after the track or chapter being played has finished.

23 STILL / STEP keys (CAV)

▶ : This key is used to display a still picture or for frame-by-frame play in the forward direction during LD (CAV) / CDV-LD (CAV) disc play.

If this key is pressed once, the picture freezes.

Every time it is pressed again, the picture advances frame-by-frame.

◀ : This key is used to display a still picture or for frame-by-frame play in the reverse direction during LD (CAV) / CDV-LD (CAV) disc play.

If this key is pressed once, the picture freezes.

Every time it is pressed again, the picture reverses frame-by-frame.

* This function is not available for CLV discs.

* If either of these keys is kept pressed, the picture will move frame-by-frame every 0.3 second.

* In this mode, sound is not produced.

24 QUICK INDEX MULTI SPEED PLAY keys (CAV, CLV)

For CAV discs:

▶ : This key is used to advance the picture at the speed selected by the SPEED keys during LD (CAV) / CDV-LD (CAV) disc play.

◀ : This key is used to reverse the picture at the speed selected by the SPEED keys during LD (CAV) / CDV-LD (CAV) disc play.

To resume normal play, press the PLAY key.

This function is not available for CLV discs.

* In this mode, sound is not produced.

For CLV discs:

The indexes are automatically assigned every 5-minute interval from the beginning of the disc for the quick index search operation.

▶ : Pressing this key searches for the assigned point in forward direction and the player enters normal playback mode.

◀ : Pressing this key searches for the assigned point in reverse direction and the player enters normal playback mode.

This function is not available for CDV and CD discs.

25 SPEED set keys (CAV)

These keys are used for selecting the play speed within 10 steps during multiple speed play (see "MULTIPLE SPEED PLAY" section.) on CAV discs. Pressing the UP key increases the speed and pressing the DOWN key decreases it.

ON-screen display	*12	*3	-----
Speed	12 times faster (x12)	3 times faster (x3)	-----

26 MODE key (CD, CDV, CDV-LD)

Pressing this key displays the TIME (track time), TOTAL time or REMAIN time.

27 DISPLAY key (CDV, CDV-LD, LD)

With LD (CAV) / CDV-LD (CAV) discs, when this key is pressed during play, the chapter and frame numbers of the picture currently being seen are displayed on the screen.

With LD (CLV) / CDV-LD (CLV) discs, when this key is pressed during play, the chapter number and time are displayed.

* Some discs do not have chapter data, so the chapter number will not be displayed even when the DISPLAY key is pressed.

With the video section of a CDV disc, pressing this key displays the TOTAL time, REMAIN time or TRACK time on the screen.

28 Numeric keys

These keys are used to select the desired chapter number, frame number or time number of the CDV-LD / LD disc, or the track number, index number, or time number of the CD or CDV disc for the various search modes.

+10 key:

This key is used to set the 10's digit.

Example — To set 10, press the "+10" key and the "0" key.

To set 17, press the "+10" key and the "7" key.

To set 53, press the "+10" key 5 times, and then press the "3" key.

- The "+10" key can be used only for the chapter number, track number or index number.

29 PLAY key

This key has entirely the same function as the PLAY key on the player.

30 PAUSE key

This key has entirely the same function as the PAUSE key on the player.

31 STOP key

This key has entirely the same function as the STOP key on the player.

32 CHAPTER/TRACK keys

These keys have entirely the same function as the CHAPTER / TRACK key on the player.

33 SEARCH keys

These keys have entirely the same function as the SEARCH key on the player.

34 REPEAT key

This key is used to set repeat mode to either single or full. It is also used to release repeat mode (single, full or A-B repeat mode). (See "REPEAT PLAY" section.)

35 A-B repeat key

This key is used to specify the beginning point and the end point for A-B repeat play.

36 VHF select key

Press this key to select the signal from either the ANT IN input signal (such as a TV broadcast signal) or the player signal.

The selected signal is output to the VHF OUT terminal on the rear panel. To select the input signal from the ANT IN, press this key so that the ANT indicator lights. To select the player signal, press this key so that the ANT indicator is not lit.

37) D/A-CX key (CDV-LD, LD)

When playing digital sound disc, press this key to select the sound mode of a disc between digital and analog. The selected mode is displayed on the screen for about 2 seconds.

When playing analog sound discs with the  mark, this key is also used to manually turn ON / OFF the CX noise reduction system.

38) SOUND select key

This key is for selecting the sound to be played from the disc and output from the R/L AUDIO SIGNAL output jacks.

The selected audio signal changes in the order of STEREO → 1 / L-CH → 2 / R-CH every time the key is pressed. (See "DISC PLAY" section.)

39) PROG. MEMORY key

Press this key in stop mode to set the unit to program mode. (See "PROGRAM PLAY" section.)

This key is also used for the memory search function of each disc. (See "MEMORY SEARCH" section.)

40) FRAME-TIME/INDEX key

Press this key to perform a frame search on a CAV disc or a time search on a CLV disc. (See "SEARCH OPERATION".)

During CD or CDV play, press this key for an index search. (See "SEARCH OPERATION".) This key is also used for memory search. (See "SEARCH OPERATION".)

41) CLEAR key

Press this key to erase the selected number for a frame search, time number search or program play. This key is also used to clear the specified mode.

42) VOLUME control keys

These keys are used to increase or decrease the output volume level.

NOTES ON THE REMOTE CONTROL TRANSMITTER

BATTERY INSTALLATION

1. Remove the battery compartment cover.
2. Insert two size "AAA" batteries verifying the correct (+ / -) polarity.
3. After loading the batteries, close the cover until it clicks.

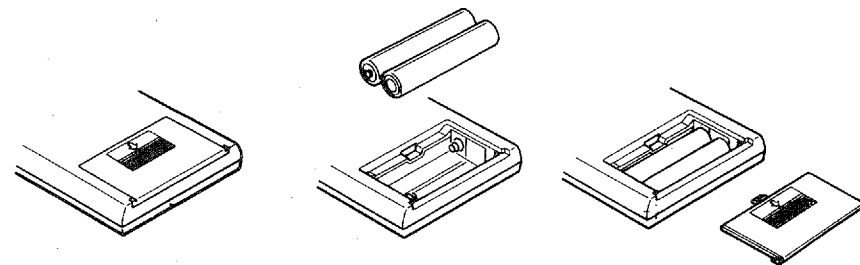

REPLACING THE BATTERY

When the remote-controllable distance decreases, the batteries are weak. In this case, replace the batteries ...

- Always insert batteries into the battery compartment correctly matching the positive (+) and negative (-) polarities as shown in the display inside the compartment.
- Never mix new and used batteries together.
- Batteries of the same size may have different voltages. Do not mix different types of batteries together.

Remote control transmitter operation

- When the remote control transmitter is not to be used for a long period of time, remove the batteries to avoid damage from possible battery leakage.

To prevent a serious accident ...

- Never disassemble, heat up the batteries or throw them into the fire. When dumping, dispose them with noncombustibles.
- Never short-circuit the battery by connecting the positive and negative polarities directly with a piece of metal, etc.

When leakage happens ...

- Wipe off the battery fluid inside the battery compartment completely, and load new batteries.

■ OPERATION RANGE OF THE REMOTE CONTROL TRANSMITTER

Usable range of the remote control transmitter.

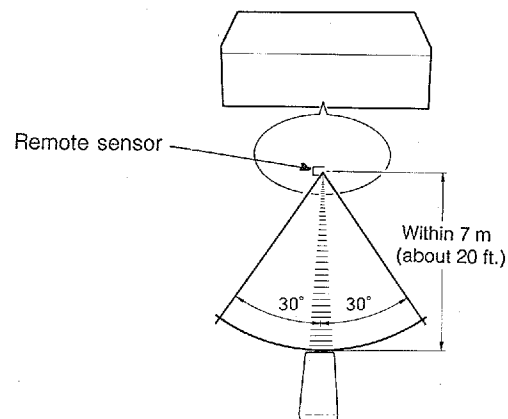

When the remote control transmitter does not function ...

When this happens, the batteries may be exhausted. Replace with new ones. And check the player's power.

Careful operation is required

Do not spill liquids on the remote control transmitter and do not subject to the excessive shock or drop it.

Take care not to leave the remote control transmitter in an excessively hot or highly humid place, such as near a heater or in the bathroom.

Be careful not to expose the remote sensor to intense light or direct sunlight. When the remote sensor is exposed to intense light, the remote control transmitter may not function or become difficult to operate.

DISC HANDLING PRECAUTIONS

■ DO NOT USE DAMAGED DISCS

Discs rotate inside the player at high speeds. Do not use damaged (warped, cracked, etc.) discs. The player may be damaged.

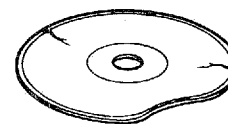

■ HOW TO TAKE OUT THE CD OR DVD DISC

Open the CD or DVD storage case with both hands, hold the disc by the edges and take out the disc while pressing the center clip.

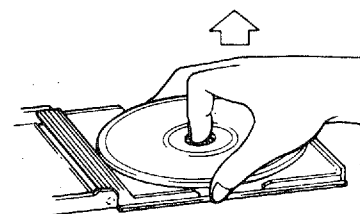

CD or DVD

■ DISC HOLDING

Holding with both hands ...

Hold the disc by its rims with both hands, as shown below.

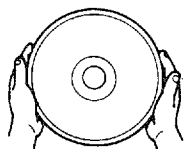

Holding with one hand ...

Hold the disc by its center hole and rim, as shown below.

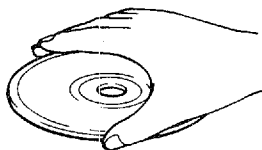

CD or CDV

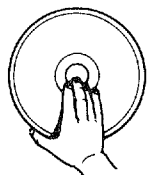

LD

Do not stick a paper, etc. on the disc surface or touch it with your finger.

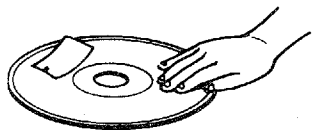

■ DISC MAINTENANCE

In order to obtain the highest quality picture and sound from your discs, wipe of dust, dirt or finger-prints on the surface of the disc using soft cloth, etc. before use.

When extremely dirty, dip a soft cloth into water, wring it out, and wipe out in a radial direction. Then, using a dry cloth, wipe it again.

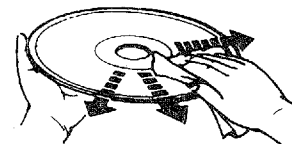

Wipe out in a radial direction.

Scratched discs may not play or may cause abnormal noise in the player. Avoid playing such discs, since they may overload the player's mechanism. Do not use record cleaner sprays, benzene or static prevention sprays, etc. on discs.

■ DISC STORAGE

To prevent warping, remove a disc from the player after playing. Then return it to its envelope and store it vertically in a location not subject to high temperature or humidity. Be sure to read all instructions printed on discs and their jackets.

DISC PLAY

1. Press the POWER switch to turn the player on.
2. Press the OPEN/CLOSE key on the player, or the OPEN/CLOSE-FULL AUTO PLAY key on the remote control transmitter, to open the disc tray.
3. Place a disc on the disc tray.
When playing a 3-inch CD disc:
Set the disc on the innermost guide with the label side facing up.
When playing a 5-inch CD or CDV disc:
Set the disc on the next guide with the label side facing up.
When playing an 8-inch disc:
Set the disc on the 8 in/20 cm guide.
When playing a 12-inch disc:
Set the disc securely within the outermost guide, with the label side you want to play facing up.

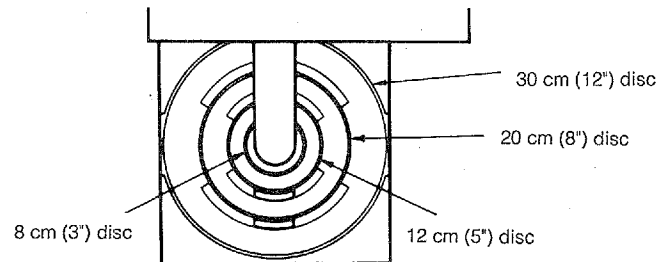

4. Close the disc tray.
There are 3 ways to close the disc tray.
 - Push the disc tray lightly.
 - Press the OPEN / CLOSE key on the player or the OPEN / CLOSE-FULL AUTO PLAY key on the remote control transmitter.
 - Press the PLAY key.Play will start automatically.
With a CD, play starts from the beginning of the first track.
With a CDV, play starts at the beginning of the video section. When play of the video section is completed, the audio section is automatically played.
With CDV-LD / LD, play starts at the beginning of the disc.

NOTES:

- Do not move the player during play.
During play, the disc rotates at a high speed. In this condition, lifting the player up or moving it may damage the disc surface. When moving the player, be sure to stop the unit and remove the disc.
 - Be sure to close the disc tray.
A strong force (especially in a vertical direction) applied to the disc tray when out, may cause malfunction.
Do not place any objects, other than discs, on the disc tray, and be sure to close it after use.
 - Do not place two or more discs together.
5. To temporarily stop play, press the PAUSE key.
To resume play from the pause point, press the PLAY key.
 6. To take the disc out of the player...
Press the OPEN / CLOSE-FULL AUTO PLAY key on the remote control transmitter, or the OPEN / CLOSE key on the player. The player enters stop mode and disc rotation stops.
Wait for a while before opening the disc tray.
When the disc tray is fully open, remove the disc from the disc tray.
- **To display the chapter and frame numbers of an LD, CDV-LD or CDV, or the track/index numbers of a CDV on the monitor screen**
Press the DISPLAY key on the remote control transmitter.
 - When playing a CAV disc, the chapter and frame numbers are displayed.
 - When playing a CLV disc, the chapter and time numbers are displayed.
 - When playing a CDV-LD (CAV) disc, the chapter, frame and index numbers and track time are displayed.
 - When playing a CDV-LD (CLV) disc, the chapter, time and index numbers and track time are displayed.
 - When playing the video section of a CDV, the track / index numbers and track time are displayed.

● **To display the time data of CD, CDV, CDV-LD discs**

With CDV-LD discs, each time the MODE key is pressed during play or pause mode, the time display changes in the order: frame No. (time No.) → TIME (from the beginning of the track being played) → TOTAL time (from the beginning of the disc) → REMAIN (remaining time of the disc).

With CDV discs, each time the MODE key is pressed during play or pause mode, the time display changes in the order: TIME (from the beginning of the track being played) → TOTAL time (from the beginning of the video section or audio section which contains the track being played) → REMAIN (remaining time of the video or audio section which contains the track being played).

With CD discs, each time the MODE key is pressed during play or pause mode, the time display changes in the order: TIME (from the beginning of the track being played) → TOTAL time (from the beginning of the disc) → REMAIN (remaining time of the disc).

● **For discs with automatic picture stop function (CAV)**

Some CAV discs have a special information signal, called the Picture Stop Code, recorded on them.

When playing these discs, the player automatically enters still play mode when play reaches the frame designated by the picture stop code. Normal play will continue by pressing the PLAY key, etc. For more details, refer to the disc envelope.

■ **SELECTING THE SOUND MODE**

When power is turned on, the player is in stereo mode.

Thus, when playing a disc having bilingual sound tracks, the two languages are mixed. In this case, press the SOUND key on the remote control transmitter so that only the desired language is obtained. Every time the SOUND key is pressed, the sound track changes in the order 1 / L channel + 2 / R channel → 1 / L channel → 2 / R channel → 1 / L channel + 2 / R channel. (When this key is first pressed, the mode is displayed on the monitor screen. Press it again to change to the next mode.)

[Reproduced sound mode]

Sound track indicator (Display window)	VHF OUT output	AUDIO SIGNAL output	
		L	R
1 / L 2 / R	Mixture (mono) of 1 / L and 2 / R	1 / L	2 / R
1 / L	1 / L	1 / L	1 / R
2 / R	2 / R	2 / R	2 / R

* When the disc tray is opened and closed again, the selected sound track mode is cancelled and Stereo mode is automatically selected.

■ SELECTING THE ANALOG / DIGITAL AUDIO SIGNAL

In CDV-LD and some LD discs, the audio signal is recorded in both digital and analog format and the audio signal can be selected (refer to the disc envelope). With these discs, the digital signal is first selected automatically (the DIGITAL indicator lights up). To select the analog audio signal, press the D / A•CX key so that the ANALOG indicator lights up.

● Playing a disc bearing the mark

With a disc bearing the  mark, the contents recorded in analog and digital formats differ. With these discs, set the SOUND key and D / A•CX key to select the desired audio signal.

	Digital signal	Analog signal
Movie	Main	Sub
Dual music	Music 1	Music 2
Multi-channel stereo sing along	Sing along	Support, Sub vocal
Bilingual	Native language	Foreign language
Tri-lingual	Native language	1L channel: foreign language 1 2R channel: foreign language 2
Quad-lingual	1L channel: native language 2R channel: foreign language 1	1L channel: foreign language 2 2R channel: foreign language 3

* On some bilingual discs, the contents are recorded as an analog signal only.

■ WHEN PLAYING A DISC HAVING THE MARK

The CX noise reduction circuit improves the signal-to-noise ratio and expands the dynamic range; resulting in noiseless, high fidelity sound. On CX discs, a special code is recorded which automatically turns the CX system on. The player reads the code to turn the CX circuitry on automatically. On some CX discs, it is necessary to manually activate the CX Noise Reduction system. With these discs, press the D / A•CX key so that "CX ON" appears on the screen. To deactivate the CX Noise Reduction system, press this key again. "CX OFF" is displayed on the screen for about 2 seconds.

*  is a trademark of Columbia Broadcasting System Inc.

■ SINGLE PLAY

With this function the player enters pause mode after playing a track or chapter. Press the SINGLE PLAY key on the remote control transmitter. After the track or chapter being played is finished, the player enters pause mode. (The "S" indicator is flashing during play.) To resume play, press the PLAY key.

SEARCH OPERATION

■ SCAN SEARCH

Press the ►► key on the remote control transmitter to fast-forward play, and press the ◀◀ key to fast-reverse play. For the first 3 seconds after being pressed, the picture is played 15 times faster than normal speed.

Then, play is advanced 60 times faster.

In this mode, sound from an LD / CDV-LD and the video section of a CDV is not produced.

When the SEARCH key is pressed, the picture is fast-forwarded or fast reversed and seen on the monitor screen.

* When playing a CLV or the video section of a CDV, the picture may fluctuate on the screen

■ CHAPTER/TRACK SKIP

The beginning of the next or the current chapter (LD, CDV-LD) or track (CD, CDV) can be located with this function.

- To skip to the beginning of the next chapter / track, press the "+" key.
 - * When the chapter number of a CDV or CLV exceeds the recorded number when trying to skip, the "+" key will not function.
- To skip to the beginning of the current chapter or track, press the "-" key.
 - * Watch the numbers when pressing the key for reverse skipping. Press it once to skip to the beginning of the current chapter or track, press it twice to return to the beginning of the chapter or track before the current one.
 - * Chapter skipping on an LD does not function for discs without chapter numbers.

When the key is pressed repeatedly, the play skips according to the times it is pressed.

When these keys are pressed during program play, play moves to the next or previous programmed selection.

■ CHAPTER / TRACK SEARCH

This function searches for the beginning of any desired chapter (LD, CDV-LD) or track (CD, CDV).

To designate the chapter or track number, use the numeric keys on the remote control transmitter.

For example, to search for chapter or track 8

Press the "8" numeric key. The player enters search mode. Chapter or track 8 is played from the beginning.

* When chapter search is performed during still mode with an LD (CAV / CDV-LD) disc, the picture is frozen at the beginning of the designated chapter. When the chapter, frame (CAV), or time (CLV) numbers exceed the recorded numbers and a search is performed, the outer edge (the end of the current program side) is reached and "END" is displayed.

On CAV discs, when the STILL / STEP or QUICK INDEX MULTI SPEED PLAY key is pressed during a search, the player will play in that mode after searching.

■ FRAME NUMBER SEARCH (CAV)

With this function, the picture of the designated frame number is located, and can be played in normal or in still mode.

To search for frame number 350

1. Press the FRAME•TIME / INDEX key.
2. Press the "3", "5" and "0" numeric keys..
3. Press the PLAY key.

The picture plays from the designated frame number point.

- When a still picture is desired, press the STILL / STEP key (◀ or ▶).

The picture is played in still mode at the designated frame number.

■ TIME NUMBER SEARCH (CLV)

With this function, the picture corresponding to the elapsed time from the beginning of the program can be located.

The elapsed time is recorded in a minimum unit of "seconds" or "minutes". For each disc, a time search operation is possible by second and / or by minute.

To search for a picture 24 minutes from the beginning of the disc

- When the time is indicated in "minutes"

1. Press the FRAME•TIME / INDEX key.
2. Press the "2" and "4" numeric keys.
3. Press the PLAY key.

The picture is played from the 24-minute elapsed time position.

- When the time is indicated in "seconds"

1. Press the FRAME•TIME / INDEX key.
2. Press "2", "4", "0" and "0" numeric keys.
3. Press PLAY key.

The picture is played from the 24 minutes elapsed time position.

■ MEMORY SEARCH

With this function, the player searches for a memorized point and play can start at that point.

1. Press the PROG. MEMORY key on the remote control transmitter at the point you want to search for.

"MEMORY" is displayed on the screen for about 2 seconds, and the frame number (CAV), time number (CLV), or track / index numbers (CD, CDV) is memorized.

2. Press the FRAME•TIME / INDEX key on the remote control transmitter to recall the memorized frame number, time number, or track / index numbers. In the case of a CD or CDV, press the FRAME•TIME / INDEX key twice to recall the memorized time.
3. Press the PLAY key. Play will start at the memorized point.

■ QUICK INDEX SEARCH (CLV)

With the function of this player that the indexes are automatically assigned every 5-minute interval from the beginning of the disc, the desired picture can be searched for playback.

- QUICK INDEX SEARCH functions only during play or pause mode. In quick search operation during pause mode, the pause mode is engaged at the specified index (time) after searching.

Pressing either of ► or ◀ of QUICK INDEX MULTI SPEED PLAY keys starts search for the first index.

Every time the key is pressed, the time is displayed on the screen with a unit of 5 minutes and play starts automatically at the specified index (time) after searching.

- An index (time) based on the time being played is displayed on the screen when pressing ► or ◀ key.

When ► key is pressed at 32:00 : TIME 35:00 is displayed.

When ◀ key is pressed at 32:00 : TIME 30:00 is displayed.

■ TRACK / INDEX SEARCH (CD, CDV having index numbers)

With this function, you can start CD or CDV play at a specified track / index number.

- To start at track 3, index 2.

1. Press the PAUSE key on the remote control transmitter to set the player to pause mode.
2. Press the "3" numeric key to specify the track number. "3" is displayed in the display.
3. Press the FRAME•TIME / INDEX key on the remote control transmitter. The INDEX indicator in the display blinks.
4. Press the "2" numeric key to specify the index number. When the disc has no index number, it is not necessary to specify the index number.
5. Press the PLAY key. Play starts at track 3, index 2.

PROGRAM PLAY

■ INDEX SEARCH (CD, CDV having index numbers)

This function searches for the beginning of any desired index number of the selection being played. To designate the index number, use the numeric keys on the remote control transmitter.

To search for index 2.

1. Press the FRAME•TIME / INDEX key on the remote control transmitter.
2. Press the "2" numeric key.
3. Press the PLAY key on the remote control transmitter.
The player searches for index 2 of the CD or CDV and play starts at the beginning of index 2.

■ PROGRAM PLAY

With this function, you can play in any desired order.

1. Press the STOP key to set the player to stop mode.
2. Press the PROG. MEMORY key on the remote control transmitter.
"PROGRAM" is displayed on the monitor screen, and a white box appears on the screen.
3. Press a numeric key to specify the chapter (CDV-LD, LD) or track (CD, CDV CDV-LD) number from which you want to play.
The specified chapter or track number is displayed on the monitor screen.
4. Repeat step 3.
Up to 15 selections can be memorized.
5. When presetting is completed, press the PLAY key on the remote control transmitter to start program play.

■ TO CORRECT THE PROGRAM

1. Press the STOP key to set the player to stop mode.
2. Press the CHAPTER / TRACK key on the remote control transmitter to move the white box to the position to be corrected.
3. Specify a new chapter or track number with the numeric keys.
4. Repeat steps 3 and 4 for other chapter or track numbers.
5. Press the PLAY key to start program play.

STILL / STEP PLAY (CAV)

■ TO DELETE A PROGRAM

1. Press the STOP key to set the player to stop mode.
2. Press the CHAPTER / TRACK key on the remote control transmitter to move the white box to the position to be deleted.
3. Press the CLEAR key.

■ TO CLEAR ALL PROGRAMS OR PROGRAM MODE

1. Press the STOP key to set the player to stop mode.
 2. Press the CLEAR key twice.
All programs are cleared and the programmed numbers disappear.
In this mode, you can reprogram the chapter or track with the numeric keys, or resume normal play with PLAY key.
 3. Press the CLEAR key once more.
Program mode is cleared and the player enters stop mode.
- Program mode is also cancelled when the disc tray is opened or when power is turned off.

■ STILL PLAY (CAV)

The picture can be frozen by pressing either of the STILL / STEP keys (◀, ▶) on the remote control transmitter. During still/step play, the frame number is displayed in white on the screen. (To check this, press the DISPLAY key.)

● Fast forward / reverse in still mode

In still mode, when the SEARCH ►► key is pressed, the picture is fast-forwarded, and re-enters still mode when the key is released. In the same way, when the SEARCH ◀◀ key is pressed, the picture is fast-reversed, and re-enters still mode when the key is released.

■ STEP PLAY (Frame-by-frame play)

[Forward direction]

After entering still mode by pressing the ▶ key, the picture is advanced frame-by-frame every time the ▶ key is pressed. When the key is kept pressed, the still picture is advanced continuously.

[Reverse direction]

After entering still mode by pressing the ◀ key, the still picture is reversed every time the ◀ key is pressed. When the key is kept pressed, the still picture is reversed continuously.

■ TO RESUME NORMAL PLAY

Press the PLAY key.

REPEAT PLAY

■ TO REPEAT THE SINGLE SELECTION

Press the REPEAT key during play of selection to be repeated. The REPEAT S indicator lights on the display. "REP S" is displayed on the screen and the single selection of the disc is repeatedly played.

■ TO REPEAT THE ENTIRE SIDE OF THE DISC

Press the REPEAT key twice so that the REPEAT F indicator lights on the display. "REP F" is displayed on the screen and the entire side of the disc is repeatedly played.

■ A-B REPEAT PLAY

This function allows you to repeat play an interval between any 2 points you designate.

1. At the beginning of the interval you want to repeat play, press the A-B repeat key. At this time, point A is designated. "REP A" is displayed on the screen for several seconds, and A \longleftrightarrow B flashes on the display.
 2. At the end of the interval you want to repeat play, press the A-B repeat key again. At this time, point B is designated and "REP B" is displayed on the screen for several seconds. At this time, REPEAT A \longleftrightarrow B is illuminated on the display. Then the interval between points A and B is played repeatedly.
- * During A-B repeat play, the interval points can be re-designated.

NOTE:

The repeat interval on CLV discs:

With CLV discs, repeat play is performed by the time numbers recorded on the disc. CLV discs are divided into two types: discs with a minimum unit of "seconds" and discs with a minimum unit of "minutes". For this reason, the interval set with the A-B key may not exactly agree with the actual repeat interval when playing discs having a minimum unit of "minutes".

For a disc with a minimum unit of "minutes", the minimum interval for repeat play is one minute. Therefore, when the A-B key is pressed with the same "minute" indicators as the start and end points, a one-minute repeat play will be performed.

■ PROGRAM REPEAT

During program play, single or entire program repeat is possible, but A-B repeat cannot be carried out.

■ TO CANCEL THE REPEAT PLAY

Press the REPEAT key to cancel single, entire side repeat, or A-B repeat play. ("REP OFF" is displayed on the screen to show that repeat play is cancelled.) Single and A-B repeat modes are also cancelled when the disc tray is opened or when power is turned off.

MULTIPLE SPEED PLAY (CAV)

The desired play speed can be selected from 10 speed modes, using the SPEED (UP/DOWN) set keys on the remote control transmitter.

This function is called "multiple speed play".

When the player is set to multiple speed mode by pressing the QUICK INDEX MULTI SPEED PLAY ► key (for forward play) or QUICK INDEX MULTI SPEED PLAY ◀ key (for reverse play), the x3 speed mode (3 times faster) is automatically set. To speed play up, press the SPEED UP key, and to slow it down, press the SPEED DOWN key.

DOWN key	On-screen display	Play speed		Up key
When the power is turned on and the unit is set to multiple speed play mode	*12	x12	High speed	Every time the key is pressed, play speed becomes higher.
	*3	x3		
Every time the key is pressed, play speed becomes slower.	*2	x2	Low speed	
	*1	*Standard		
	1/2	1/2		
	1/4	1/4		
	1/8	1/8		
	1/16	1/16		
	1 SEC	1 frame/sec		
	3 SEC	3 frame/sec		

- * The selected speed is stored in memory even when the player enters other modes. However, when power is turned off, x3 mode resumes.
- * Play speed can be preset by pressing the SPEED UP or DOWN key before entering Multiple Speed mode (in any mode).
- * During multiple speed play (even at standard speed), sound is not produced.

■ HIGH-SPEED PLAY

To play at x12 speed

1. Press the MULTI. SPEED PLAY ► key. (For reverse play, press the ◀ key.)
At this time, the picture is played at x3 (3 times the normal) speed.
2. Press the SPEED UP key once. The picture is played at x12 speed.

■ SLOW-SPEED PLAY

To play at half speed

1. Press the MULTI. SPEED PLAY ► key. (For reverse play, press the ◀ key.)
At this time, the picture is played at x3 (3 times the normal) speed.
2. Press the SPEED DOWN key three times. The picture is played slowly at half speed.

■ TO RESUME NORMAL PLAY

Press the PLAY key.

TROUBLE SHOOTING

When this unit functions abnormally during operation, first check the following items. When the unit continues to function abnormally, or when an abnormality appears other than listed below, turn off the player's power and disconnect the AC plug, then consult your YAMAHA dealer or servicing personnel.

<Video>

SYMPTOM	POSSIBLE CAUSE	REMEDY	
The disc is turning, but the picture is not played.	The TV (color monitor) power is OFF.	If it is OFF, turn the power of the TV (color monitor) ON.	
	Connections are incorrect	Connect equipment properly again.	
	When the VHF TV input is used.	The output channel used by this unit is different from the vacant TV channel.	Set the TV channel to the vacant channel (either of CH3 and CH4 which is not used by any broadcast station), then set the CHANNEL switch of this unit to "L" if the vacant channel is CH3 , or to "H" if it is CH4.
		The ANT indicator is lit.	Press the VHF key so that the ANT indicator goes off.
	A one-sided disc may be placed upside down.	Place the disc with the label on which the required program is indicated facing up.	
TV programs (VHF broadcast) can not be seen.	The VHF antenna connection is incorrect.	Connect the VHF antenna properly.	
	The ANT indicator is not lit.	Press the VHF key once so that the ANT indicator lights.	
TV Programs (UHF broadcast) can not be seen.	The UHF antenna is connected to the ANT IN jack of this unit.	Connect the UHF antenna directly to the UHF input terminal of the TV.	
Multi-speed play, still-frame-advance play and frame search are not possible.	The disc being played is a CLV or CDV disc.	The CLV and CDV discs do not allow multi-speed play, still / frame-advance play and frame search.	
The chapter skip and chapter search are not possible.	The chapter No. has not been recorded on the disc being played.	Press the DISPLAY key on the remote control transmitter and see if any chapter No. is displayed.	
The scene played by time number search is not the intended scene.	Press the DISPLAY key on the remote control transmitter, and check whether the disc's time Nos. have been recorded per "minute" basis or per "second" basis.	Refer to the description of time number search.	
TV program reception is poor, or the picture is stretchy.	The TV wave in your listening area is weak.	When viewing TV programs, turn this unit OFF.	
The picture quality is poor, or it is distorted.	The disc is very dirty.	Clean the disc.	
	The disc is deformed (warped, etc.).	Straightening the disc may sometimes reduce the deformation.	

<Audio>

SYMPTOM	POSSIBLE CAUSE		REMEDY
Playback does not start although a disc has been set in place.	The disc is placed upside down.		Place the disc with the labeled side facing up.
	The disc is very dirty.		Clean the disc.
Sound is not reproduced.	Connections are incorrect.		Connctet equipment properly again.
	A CAV disc is being played in the multi-speed play mode.		Press the PLAY key to enter the standard play mode.
	The volume control of the TV, amplifier or receiver connected is set at the minumum position.		Adjust the volume control of the TV, amplifier or receiver as required.
	When the TV is equipped with audio input jacks.	Audio cord connections are incorrect.	Connect the audio cords properly.
The sound is unnatural.	A disc without <input checked="" type="checkbox"/> marking is being reproduced with the D / A•CX key set to ON.		Press the D/A•CX key so that 'CX-OFF' is displayed on the screen.

<General>

SYMPTOM	POSSIBLE CAUSE		REMEDY
Power cannot be turned on.	The power cord is disconnected from the power outlet.		Insert it firmly.
Playback cannot be started.	No disc has been loaded.		Load a disc.
The disc table comes out involuntarily.	The disc is very dirty.		Clean the disc.
	The disc is deformed (warped, etc.).		Straightening the disc may sometimes reduce the deformation.
The remote control unit cannot be operated.	The batteries inside the remote control unit are exhausted.		Replace batteries.
	The remote control unit is operated from an incorrect distance or angle.		Operate it from less than 7 meters (about 20 ft.) and 30 °.
The TV operated erroneously when the remote control unit of this unit is operated.	When the TV used is equipped with wireless remote control.	The TV is placed near this unit.	Place the TV and this unit apart, or cover the remote control light receiver of the TV.
A hum noise is heard.	The output cord plug is connected impropely.		Insert the output plug securely again.
The tuner is interiered with noise.	The tuner is placed near this unit.		Place this unit apart from the tuner, or turn the power of this unit OFF.

SPECIFICATIONS

FORMAT

System (or Type):	Optical videodisc system complies with MCA/Philips specifications (Laservision system)
Usable disc:	CD single: 20 min. CD: 70 min. CDV: Video 5 min. Audio 20 min. 12-inch CLV disc: 60 min./side 12-inch CAV disc: 30 min./side 8-inch CLV disc: 20 min./side 8-inch CAV disc: 14 min./side LD single (CLV) disc: 20 min. LD single (CAV) disc: 14 min.
Spindle revolution:	CD: 500 to 200 rpm CDV: Video 2,700 to 1,800 rpm Audio 500 to 300 rpm CLV disc: 1,800 to 600 rpm (12-inch disc) CAV disc: 1,800 rpm

INPUT/OUTPUT TERMINALS

INPUT: ANT IN:	VHF input (75-ohms)
OUTPUTS: VIDEO SIGNAL:	1 Vp-p (75-ohms load, sync. negative) RCA pin jack
VHF OUT:	Applied to NTSC standard TV receiver F-type jack (75-ohms, unbalanced) Channel 3 or 4 switchable
AUDIO SIGNAL:	Digital: 200 mV (1KHz, -20 dB) Analog: 200 mV (1KHz, 40%) Stereo or 2-channel individual Stereo pin jacks
Frequency response:	5Hz to 20Hz +0.5,-1.0 dB(digital)
Signal-to-noise ratio:	110 dB(digital)
Dynamic range:	95 dB(digital)
Channel separation:	100 dB(digital)
Horizontal resolution:	440 lines
Distortion rate:	0.004% (1 KHz, 0 dB)(digital)
S Video Output:	.1 V, 0.286 Vp-p

GENERAL

Power requirements:	
U.S.A and Canada models	120V, 60Hz
General model	110/120/220/240, 50/60Hz
Power consumption:	35 W
Weight :	9.3 kg (20 lb 8 oz)
Dimensions:	435 (W) x 135 (H) x 413.5 (D) mm (17-1/8" x 5-5/16" x 16-1/4")
Operative temperature/humidity range:	+5 to 35°C (41 to 95°F)/0 to 90% (No condensation)

ACCESSORIES

Remote Control Transmitter
Size "AAA, R03" battery x 2
75-ohm/300-ohm antenna adapter x 1
Coaxial cable with F-type connector x 1
Audio cord x 1
Video cord x 1

OTHERS

Auto audio digital output:	When playing discs having digitally-recorded audio signal, audio reproduction circuit is automatically changed to the audio digital circuit
-----------------------------------	---

Specifications and design subject to change without notice.

YAMAHA

YAMAHA ELECTRONICS CORPORATION, USA 6722 ORANGETHORPE AVE., BUENA PARK, CALIF. 90620, U.S.A.
YAMAHA CANADA MUSIC LTD. 135 MILNER AVE., SCARBOROUGH, ONTARIO M1S 3R1, CANADA
YAMAHA ELECTRONIK EUROPA G.m.b.H. 2084 RELLINGEN, BEI HAMBURG, SIEMENSSTR. 22/34, F.R. OF GERMANY
YAMAHA ELECTRONIQUE FRANCE S.A. 17 RUE DES CAMPANULES, LOGNES 77321 MARNE LA VALLEE CEDEX 2, FRANCE
YAMAHA ELECTRONICS (UK) LTD. YAMAHA HOUSE, 200 RICKMANSWORTH ROAD WATFORD, HERTS WD1 7JS, ENGLAND
YAMAHA SCANDINAVIA A.B. J A WETTERGRENS GATA 1, BOX 30053, 400 43 VÄSTRA FRÖLUNDA, SWEDEN
YAMAHA MUSIC AUSTRALIA PTY, LTD. 17-33 MARKET ST., SOUTH MELBOURNE, 3205 VIC., AUSTRALIA

YAMAHA CORPORATION
10-1 NAKAZAWA-CHO, HAMAMATSU, JAPAN
VI34210-0 BWgW, BR Printed in Japan 